

Potain HDT 80

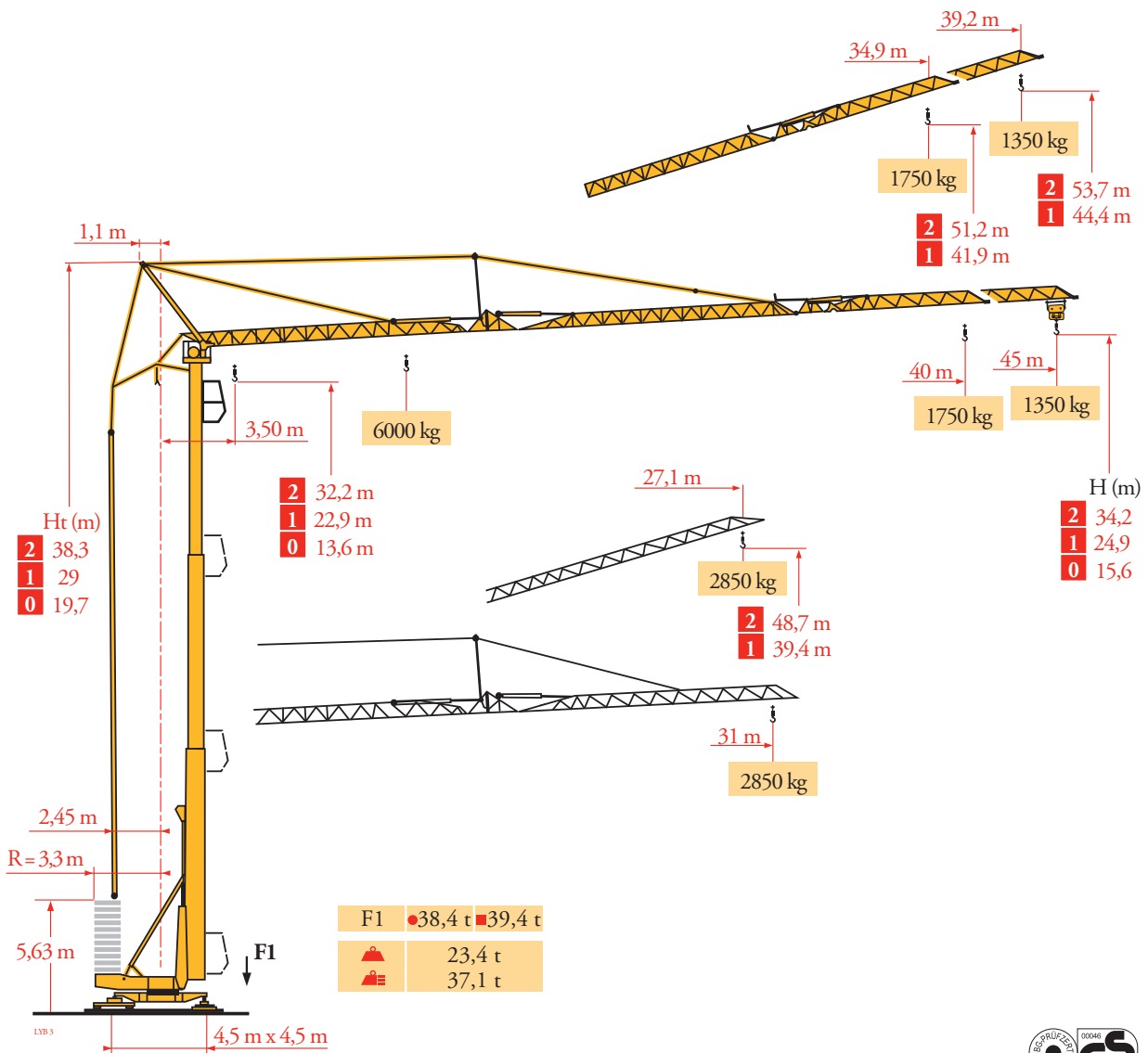

Courbes de charges
Lastkurven
Load diagrams
Curvas de cargas
Curve di carico
Curva de cargas
Диаграммы
грузоподъемностей

LYB 3

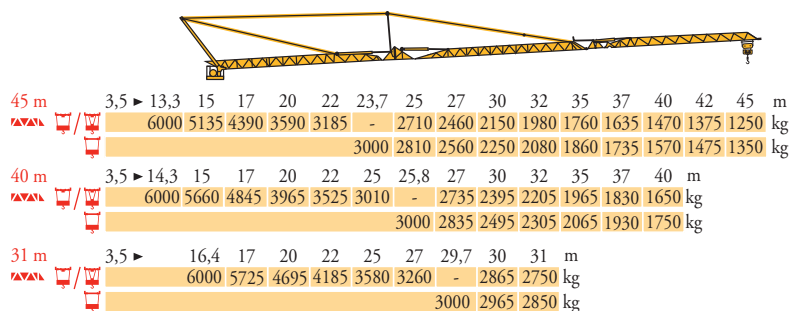

Flèche relevée
Ausleger in
Steilstellung
Luffing jib
Flecha izada
Braccio impennato
Lança inclinada
Маховая стрела

LYB 4

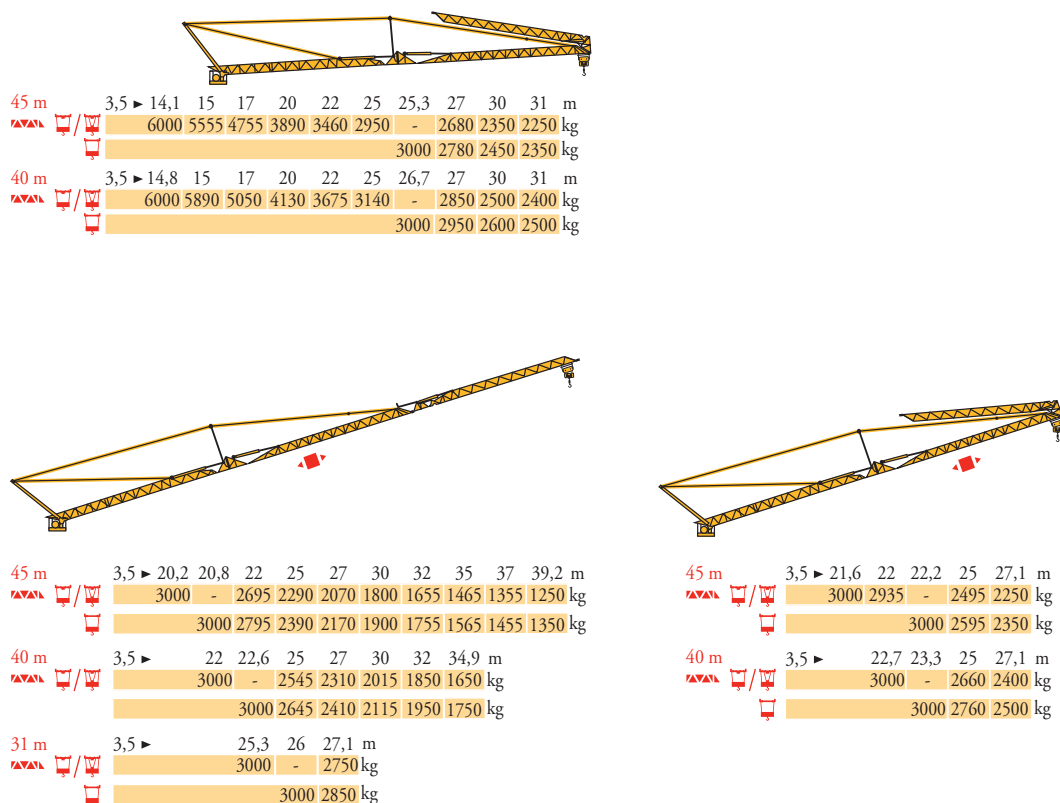

FR
 Chariot distributeur
 Réactions en service
 Réactions hors service
 A vide sans lest (ni train de transport) avec flèche et hauteur maximum.
 Poids total du lest

DE
 Verfahrbare Laufkatze
 Reaktionskräfte in Betrieb
 Reaktionskräfte außer Betrieb
 Ohne Last, Ballast (und Transportachse), mit Maximalausleger und Maximalhöhe.
 Ballast-Gesamtgewicht.

EN
 Traversing trolley
 Reactions in service
 Reactions out of service
 Without load, ballast (or transport axes), with maximum jib and maximum height.
 Gross ballast weight.

ES
 Carro distribuidor
 Reacciones en servicio
 Reacciones fuera de servicio
 Sin carga, sin lastre, (ni tren de transporte), flecha y altura máxima.
 Peso total del lastre.









IT
 Carrellino distributore
 Reazioni in servizio
 Reazioni fuori servizio
 A vuoto, senza zavorra (ne assali di trasporto) con braccio massimo e altezza massima.
 Peso totale della zavorra.

PT
 Carro distribuidor
 Reações em serviço
 Reações fora de serviço
 Sem carga (nem trem de transporte)- sem lastro com lança e altura máximas.
 Peso total do lastro.

RU
 Грузовая тележка
 Реакции при работе
 Реакции в покое
 Вес без груза, балласта (или транспортных осей), с максимальной длиной стрелы и максимальной высотой.
 общий вес груза

Mécanismes
Antriebe
Mechanisms
Mecanismos
Meccanismi
Mecanismos
Механизмы









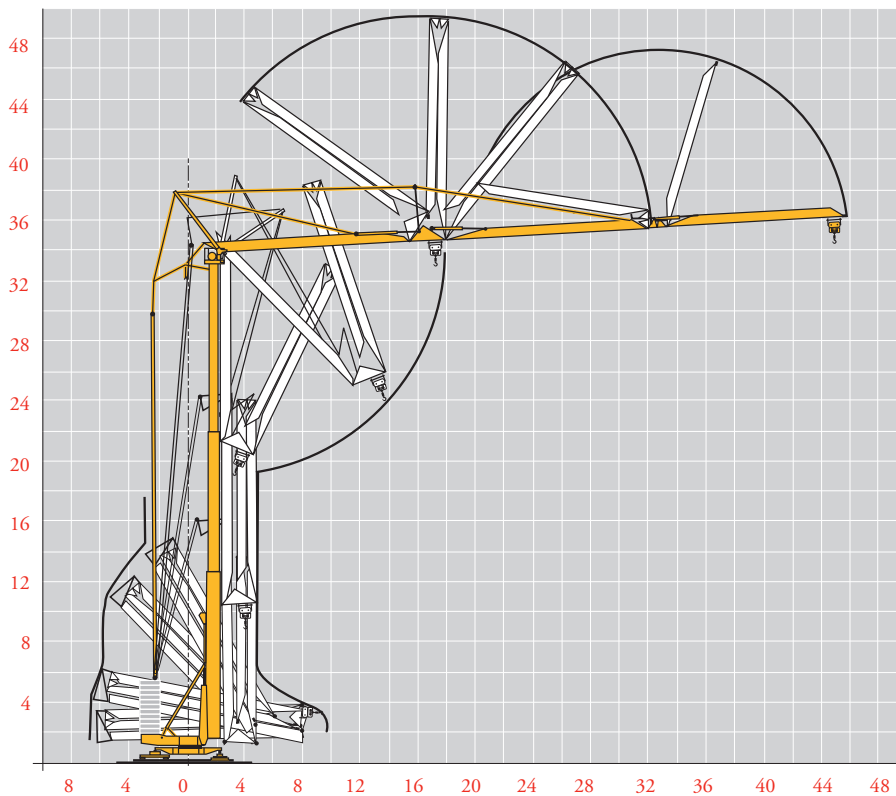



LV B 7

												ch - PS hp	kW	
	20 LVF 15	m/min	4	26	42	52	68	2	13	21	26	34	20	15
		kg	3000	3000	1800	1400	700	6000	6000	3600	2800	1400		
	5 DVF 5	m/min	9 - 22 - 58 (3000 kg)					9 - 22 - 44 (6000 kg)					6,5	4,8
	RVF+61	tr/min U/min rpm	0 → 0,8										8	5,9
	TVDS 124	m/min	25										2 x 4	2 x 3
 IEC 60204-32						 kVA								
400 V(+10% -10%) 50 Hz 480 V(+ 6% -10%) 60 Hz						20 LVF 15 : 35 kVA								

Montage
Montage
Erection
Montaje
Montaggio
Montagem
Монтаж

LV B 3



	FR	Levage		DE	Heben		EN	Hoisting		ES	Elevación		IT	Sollevamento		PT	Elevação		RU	Подъем
		Distribution			Katzfahren			Trolleying			Distribución			Ditribuzione			Distribuição			Перемещение каретки
		Orientation			Schwenken			Slewing			Orientación			Rotazione			Rotação			Поворот
		Translation			Kranfahren			Travelling			Traslación			Traslazione			Translação			Перемещение крана

Transport
 Transport
 Transport
 Transporte
 Trasporto
 Transporte
 Транспортировка

LYB 4

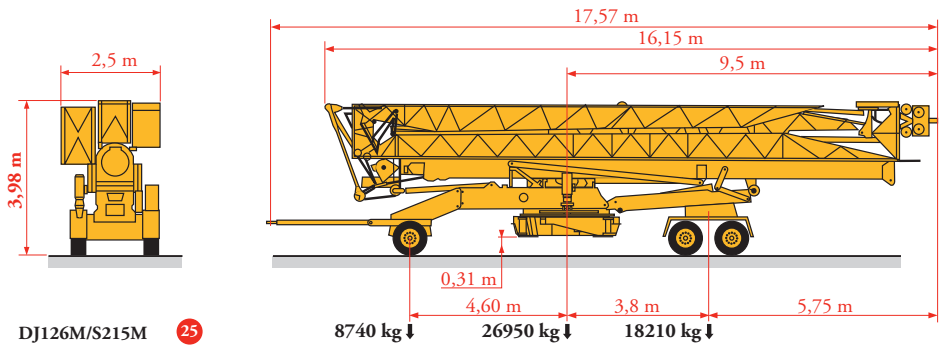

DJ126M/S215M 25

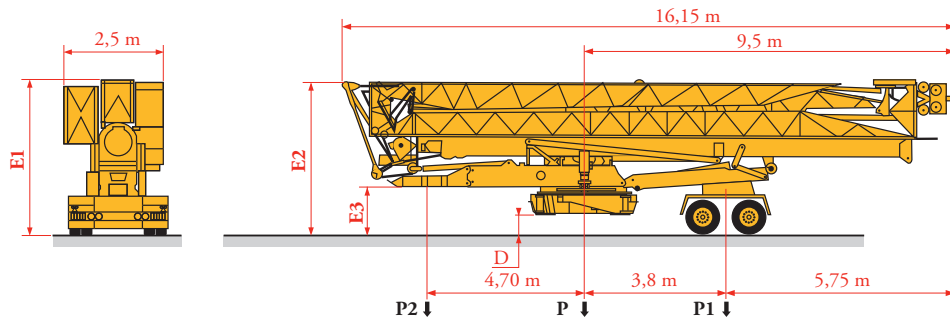

	Km/h	D (m)	E1 (m)	E2 (m)	E3 (m)	P (kg)	P1 (kg)	P2 (kg)
SL121/S215M	25	0,28 -> 0,34	3,93 -> 3,99	3,90 -> 4,0	1,20 -> 1,38	26400	18300	8100
SL122/J215M	80	0,28 -> 0,34	3,93 -> 3,99	3,90 -> 4,0	1,20 -> 1,38	26300	18200	8100



Document commercial non contractuel. Pour toute information technique se référer à la notice correspondante.

Unverbindliches Vertriebsdokument. Für technische Informationen, siehe die entsprechenden Anweisungen.

This commercial document is not legally binding. For any technical information, please refer to the corresponding instructions.

Documento comercial no contractual. Para cualquier información técnica, ver la noticia correspondiente.

Documento commerciale non vincolante, per tutte le informazioni tecniche fare riferimento al catalogo istruzioni.

Documento comercial não contractual. Para qualquer informação técnica complementar consultar as respectivas instruções.

Этот коммерческий документ не является юридически обязательным. Для получения технической информации, см. соответствующие инструкции.



Manitowoc - Americas - World Headquarters
 2400 S. 44th Street • Manitowoc • WI 54220 USA
 Tel: +1 920 684 4410 • Fax: +1 920 652 9778

Manitowoc - Europe, Middle East & Africa
 Ecully, France
 18, rue de Charbonnières B.P. 173 • 69132 ECULLY Cedex • FRANCE
 Tel: +33 (0)4 72 18 20 20 • Fax: +33 (0)4 72 18 20 00

Manitowoc - Asia Pacific
 16F Xu Hui Yuan Building,
 1089 Zhongshan No.2 Road (S) • Shanghai 200030 China
 Tel: +86 21 6457 0066 • Fax: +86 21 6457 4955