

Potain GTMR 331C

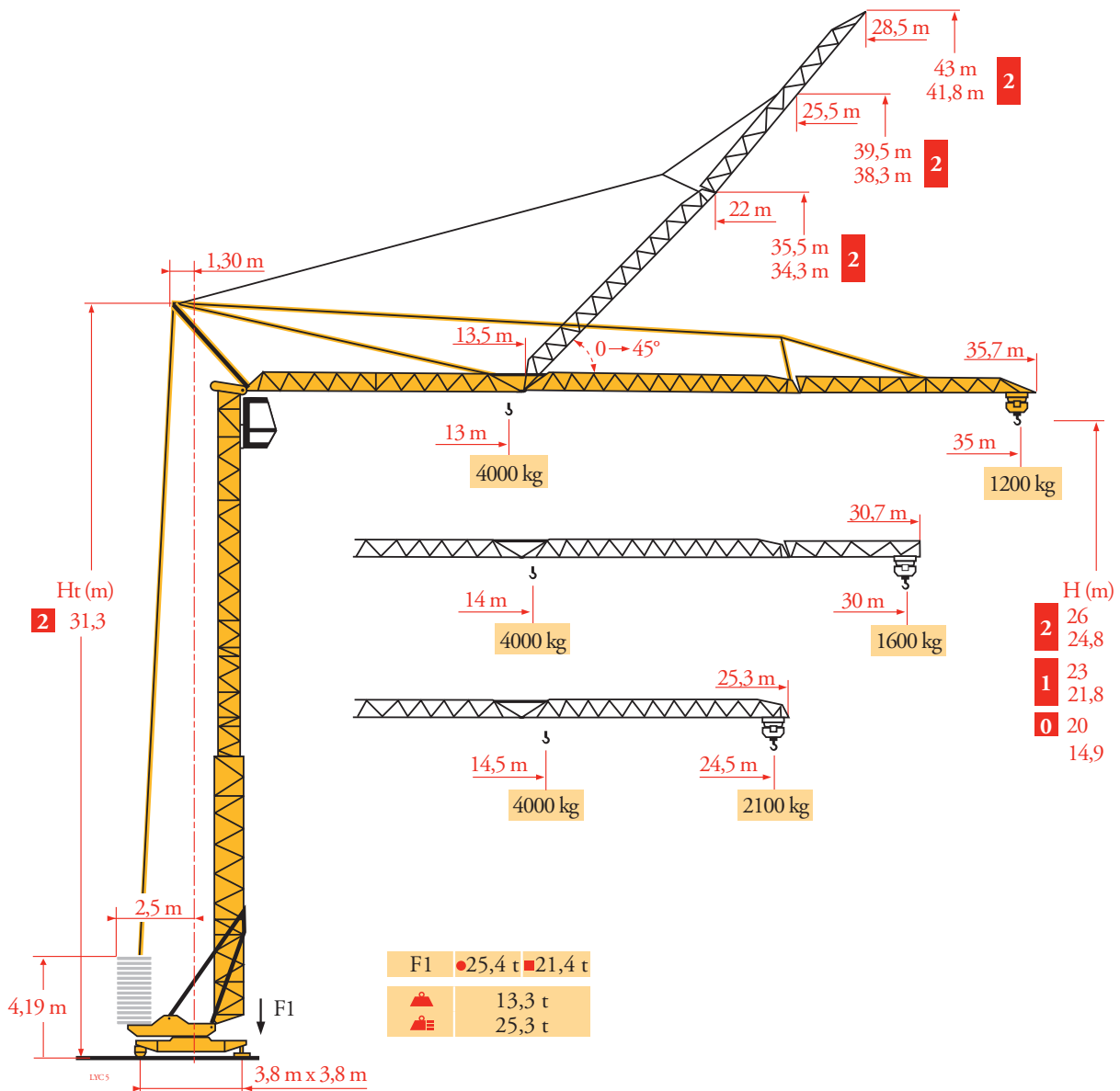

Courbes de charges
Lastkurven
Load diagrams
Curvas de cargas
Curve di carico
Curva de cargas
Диаграммы грузоподъемностей

LVC 3

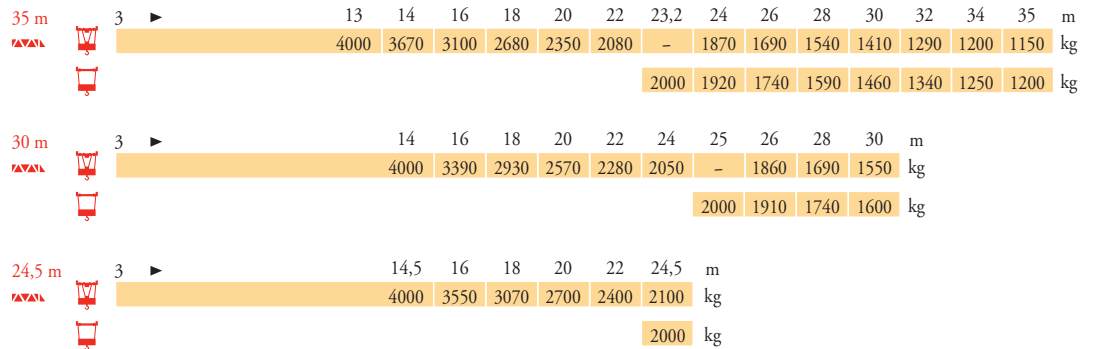

Flèche relevée
Ausleger in Steilstellung
Luffing jib
Flecha izada
Braccio impennato
Lança inclinada
Маховая стрела

LVC 4

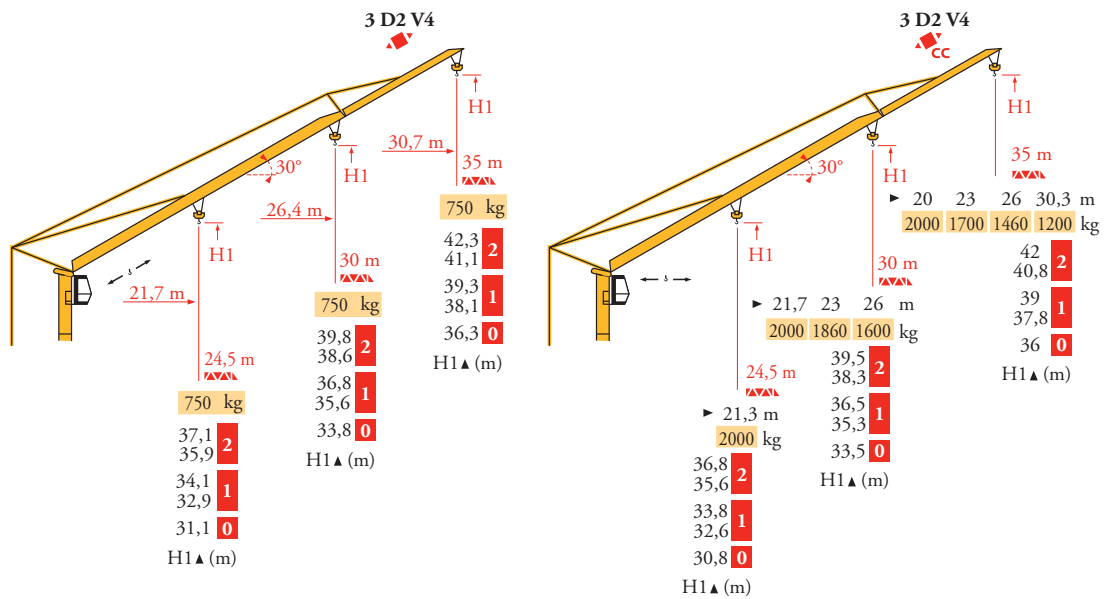

FR

Chariot distributeur
Chariot distributeur et courbes de charges
Réactions en service
Réactions hors service



A vide sans lest (ni train de transport) avec flèche et hauteur maximum



Poids total du lest

DE

Verfahrbare Laufkatze
Verfahrbare Laufkatze und Lastkurven
Reaktionskräfte in Betrieb
Reaktionskräfte außer Betrieb

Ohne Last, Ballast (und Transportachse), mit Maximalausleger und Maximalhöhe

Ballast-Gesamtgewicht.

EN

Traversing trolley
Traversing trolley and load diagrams
Reactions in service
Reactions out of service

Without load, ballast (or transport axles), with maximum jib and maximum height

Gross ballast weight.

ES

Carro distribuidor
Carro distribuidor y curvas de cargas
Reacciones en servicio
Reacciones fuera de servicio

Sin carga, sin lastre, (ni tren de transporte), flecha y altura máxima

Peso total del lastre.

IT

Carrellino distributore
Carrellino distributore e curve di carico
Reazioni in servizio
Reazioni fuori servizio

A vuoto, senza zavorra (ne assali di trasporto) con braccio massimo e altezza massima

Peso totale della zavorra.

PT

Carro distribuidor
Carro distribuidor e curva de cargas
Reacções em serviço
Reacções fora de serviço

Sem carga (nem trem de transporte) - sem lastro com lança e altura máximas

Peso total do lastro.

RU















Грузовая тележка
Грузовая тележка и диаграммы грузоподъемностей
Реакции при работе
Реакции в покое

Вес без груза, балласта (или транспортных осей), с максимальной длиной стрелы и максимальной высотой

общий вес груза

Mécanismes
Antriebe
Mechanisms
Mecanismos
Meccanismi
Mecanismos
Механизмы

LVC5

									ch - PS hp	kW	
											
	20 LVF10	m/min kg	5 2000	25 2000	50 1300	2,5 4000	12,5 4000	25 2600	22	15	
	3 D2 V4	m/min	22 - 44						4	3	
	RCV 22	tr/min U/min rpm	0 → 0,8						3	2,2	
	TVD 122	m/min	25						2 x 2	2 x 1,5	
 IEC 60204-32					 kVA						
400 V(+10% -10%) 50 Hz 480 V(+ 6% -10%) 60 Hz					20 LVF 10 : 25 kVA						

Montage
Montage
Erection
Montaje
Montaggio
Montagem
Монтаж

LVC3

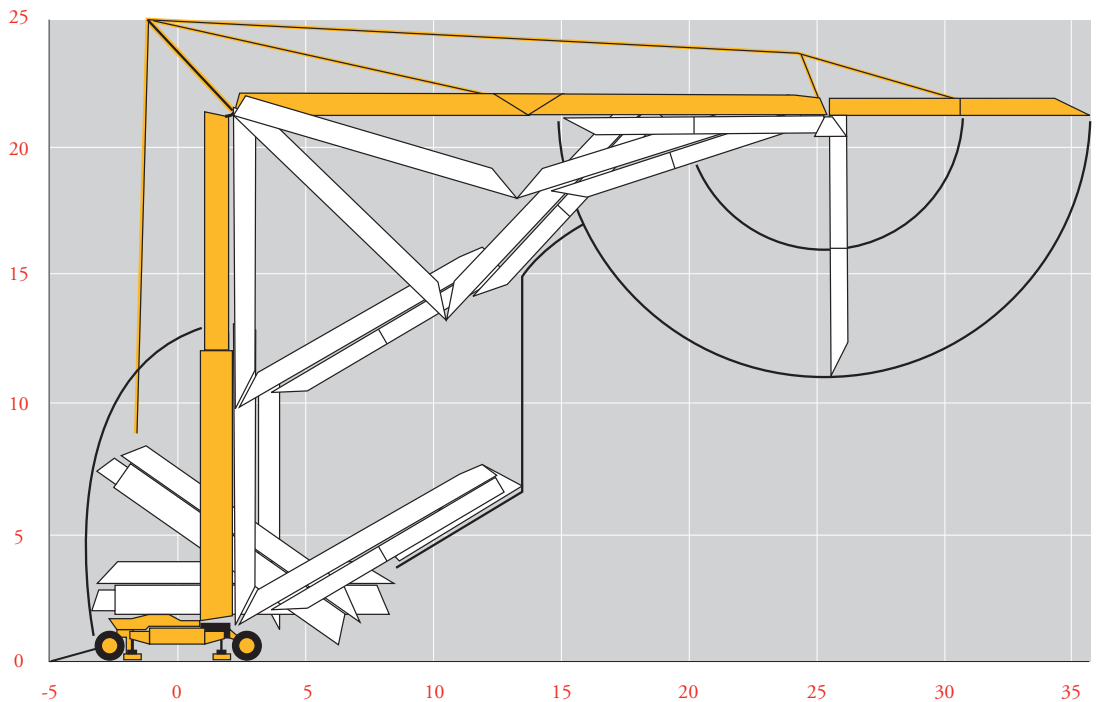

 **FR**
Levage
 **DE**
Katzfahren
 **EN**
Schwenken
 **ES**
Traslación

FR
Heben
DE
Trolleyfahren
EN
Slewing
ES
Travelling

ES
Elevación
IT
Distribuzione
PT
Rotação
RU
Перемещение каретки
 Поворот
 Перемещение крана

IT
Sollevamento
PT
Elevação
RU
Перемещение крана

PT
Distribuição
RU
Перемещение крана

Transport
 Transport
 Transport
 Transporte
 Trasporto
 Transporte
 Транспортировка

LYC 4

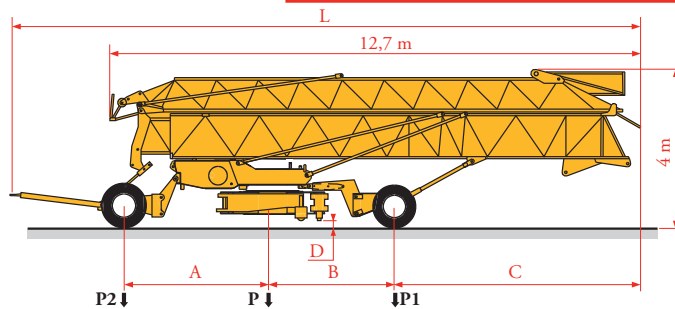
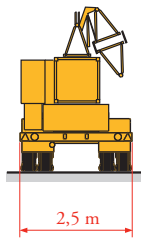

	Km/h	A (m)	B (m)	C (m)	D (m)	L (m)	P (kg)	P1 (kg)	P2 (kg)
15A/25A	25	3,64	2,91	5,81	0,24	15,06	14620	10710	3910
DJ126M/S215M	25	3,57	4,16	4,56	0,29	15,38	16200	11100	5100

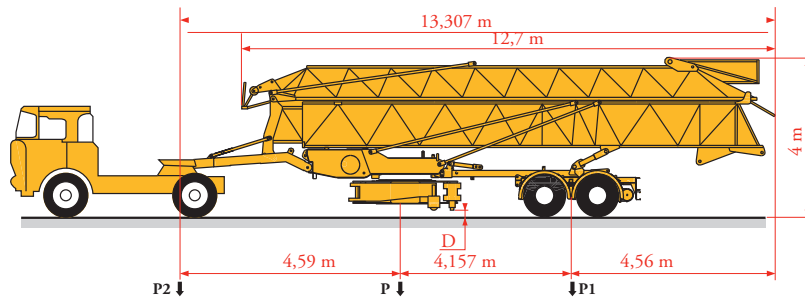
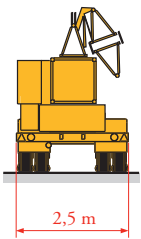

	Km/h	D (m)	P (kg)	P1 (kg)	P2 (kg)
S4/S215M	25	0,20	15900	11600	4300
S5B/J125M	80	0,24	16200	11500	4700



Document commercial non contractuel. Pour toute information technique se référer à la notice correspondante.

Unverbindliches Vertriebsdokument. Für technische Informationen, siehe die entsprechenden Anweisungen.

This commercial document is not legally binding. For any technical information, please refer to the corresponding instructions.

Documento comercial no contractual. Para cualquier información técnica, ver la noticia correspondiente.

Documento commerciale non vincolante, per tutte le informazioni tecniche fare riferimento al catalogo istruzioni.

Documento comercial não contratual. Para qualquer informação técnica complementar consultar as respectivas instruções.

Этот коммерческий документ не является юридически обязательным. Для получения технической информации, см. соответствующие инструкции.



Manitowoc - Americas - World Headquarters
 2400 S. 44th Street • Manitowoc • WI 54220 USA
 Tel: +1 920 684 4410 • Fax: +1 920 652 9778

Manitowoc - Europe, Middle East & Africa
 Ecully, France
 18, rue de Charbonnières B.P. 173 • 69132 ECULLY Cedex • FRANCE
 Tel: +33 (0)4 72 18 20 20 • Fax: +33 (0)4 72 18 20 00

Manitowoc - Asia Pacific
 16F Xu Hui Yuan Building,
 1089 Zhongshan No.2 Road (S) • Shanghai 200030 China
 Tel: +86 21 6457 0066 • Fax: +86 21 6457 4955